



Sitlington Parish

Incorporating Middlestown, Overton, Netherton & Midgley

SUMMER 2023

Still time to register for...



Netherton Scarecrow Festival
1st and 2nd July 2023



COXLEY NEWS: information for contributors

Coxley News: Launched in 2007, Coxley News, Coxley Players and the Scarecrow Festival all operate under the wider community project umbrella of Coxley Live. It covers Sitlington parish (Netherton, Middlestown, Overton & Midgley).

Issues:

Spring (March, April, May) – deadline around 15th January

Summer (June, July, August) – deadline around 15th April

Autumn (September, October, November) – deadline around 15th July

Winter (December, January, February) – deadline around 15th October

Articles: We love to hear from you! Parish groups and events have priority, each group may have up to two pages.

Advertising: covers all printing costs, so takes up half of each issue.

Charges: One-off layout fee if needed, £10. A quarter page - £15; half - £30; full page - £60. Formats such as pdf and jpg are accepted, please check with Wendy. We don't include flyers or inserts as they are time consuming and add extra weight for our team of volunteer distributors.

Distribution: 2,600 homes in Sitlington, all delivered by volunteers. Join the distribution team! Contact Joan (07734) 872215 for Middlestown/Overton and Wendy (01924) 281620 for Netherton/Midgley.

Editors: We are volunteers too. We may edit content for clarity, accuracy and length. All editors' decisions are final.

Wakefield Metropolitan District Council

Your District Councillors On Call



District Councillors: Samantha Harvey, Cynthia Binns, Jordan Bryan
are prepared to visit you at home when you need them

Call: Councillor Harvey 07471141556 Councillor Binns 07825 927986

Councillor Bryan jordanbryan35@gmail.com

Coxley News team

Editorial: Shirley Jones, Wendy Woodhouse, Helen Moretti, Pete Fearnside, Joan Fearnside.

Design and Production: Helen Moretti.

Advertising: Wendy Woodhouse.

Delivery: Cast of many but **we would love to hear from you if you can help!**

Editorial comment

Welcome to summer – finally! Hopefully everyone enjoyed the flurry of bank holidays May had to offer, perhaps you were making a start on your scarecrows for our festival in July? Or like Jay Whittam, enjoying the garden springing into all kinds of life.

If you fancy venturing a bit further afield, take a leaf out of our walking correspondent's book and board a steam train from Pickering to Whitby, with added rambling and cake along the way.

And finally, we learn that black is back for those who like a chic summer wardrobe, so dig out those crocheted and chiffon numbers.

Send us your news for the autumn issue (for September, October and November) by July 17th please.

Contact the Coxley News team by

E-mail: coxley.158@btinternet.com **Phone:** 01924 276545

Post: 158 Coxley View, Netherton, WF4 4NE

Adverts

Email: wendy.coxley@talktalk.net **Phone:** 01924 281620

How to Contact the Parish Council

The contact for the parish council is the clerk, Mrs Julia Talbot.

(07771 113258) clerk@sitlingtonparishcouncil.gov.uk

Parish Office, Stevenson House, 139 Netherton Lane, Netherton, WF4 4HQ

To book Netherton Village Hall contact Parish Clerk.

News From Trinity Methodist Church, Netherton

Summer is a relatively quiet time for special events, but our regular groups continue to meet as follows:

Sunday Worship every Sunday at 10:30 for about an hour, followed by the chance for a chat over a cup of tea or coffee.

Knit & Natter Group meets every first and third Monday at 1:30pm in church

Chapel Cafe is open every last Saturday in the month, 10 until 12. Come and enjoy the company with a changing menu of tasty snacks every month. If you wish to use the openness of Chapel Café to promote a charity, we can supply you with a stall from which you can advertise and raise money.

Film Club is on the third Friday of each month at 7:30 (doors open 7:15). Admission is free (donations appreciated), with refreshments on sale. In addition, there is an occasional Film Club Extra. Please contact Colin for details of what films are coming up.

Trinity Lunch Stop continues the first Wednesday of each month at 12 for 12:30. Booking is essential through Carole and Andrew Shaw.

Bible Fellowship meets Wednesday evenings, generally second and fourth, but please check with Colin for exact dates, times, and details.

Reading for Pleasure book club meets every second Monday, 7pm in The Star, Netherton.

Trinity Methodist Friendship Club meets at church on the afternoon of the third Wednesday of the month from 1:30pm until 3:30. All are welcome to share in various activities or just to chat and meet friends.

Contact Carol Smith (079 408 64708) for further details.

For further information about any of the above contact:

Sandra & Colin Ride 01924 271553

Alan Wood 01924 271210

Carole Shaw 01924 275414

Christine Hewitt 07931 353082



HYPNOTHERAPY

EST 2011

I'm Helen and I'm a clinical hypnotherapist working with people with issues such as anxiety, alcohol, phobias, difficulty losing weight, smoking and much, much more.



07585 898 906

Contact me today to find out how I can help you improve your life and to book your free consultation.



helen@helenthehypnotist.co.uk

www.helenthehypnotist.co.uk

Adrian's School of Motoring

Learn to Drive With Confidence

www.adrians-som.co.uk

Your friendly local driving school offering practical lessons structured to meet your individual needs.

Home 01924 281620

Mob 07729 266138



Manor Services

Landscape and Garden Maintenance Contractor

Garden Maintenance,

Dry stone walling,

Patios

Fencing

Treatment of Japanese Knotweed

Landscaping

Decking

Block paving

Tree Surgery

Maintenance of graves

Contact: Richard Searby for a no obligation quotation

Mob: 0777 956 2501 Fax: 01484 307628

Email: manorservices33@gmail.com



Creative Little Ones

We welcome Families/Carers to our toddler group, based in Netherton at the Methodist Church.

Monday mornings 09:00 - 11:00 am, £1 per head

There will be refreshments and snacks for the children.

The morning will include playing, singing, story time & a chance for you to unwind with a coffee/tea and a nice chat with new people

Any queries, please message the group,
Lisa 07969 853522 or Lorna 07827 767974

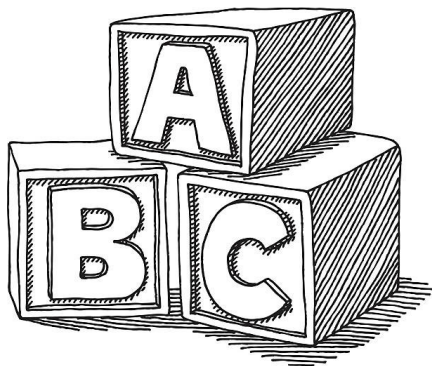

Cath Finegan ND, mFNTP, Hlr

Naturopath and Nutritional Therapist



- **Are you suffering with....**
- Stress? - Fatigue? / Exhaustion?
- Thyroid issues? - Digestive issues?
- Food Intolerances? - Hormonal issues?
- I'm an experienced Naturopath and Nutritionist working with people with fatigue and chronic exhaustive conditions, thyroid issues, digestive complaints and hormonal issues.
- Diet and lifestyle play a significant part in our overall health. Nutrition must be optimal in order to provide the most favourable conditions for energy production and allow your body the best chance of healing.
- Contact me today to find out how I can help you to make the changes needed in order to improve your health.
- Contact **Cath** on 07772 736671
- cath@naturopath.me.uk www.naturopath.me.uk



Walk with OTIS

Dog Walking Service

Keep your dog fit, happy and healthy



Call Rob on:
07500009665

or email:
bob.basir@gmail.com

£10.00 an hour

Summer vibes.....

Having glimpsed a bit of double-figure temperatures – I think it's official – Spring is here and we can tentatively start to look forward to blue skies, sunshine, lazy days and holidays. It's time to pack away your cosy sweaters and see what's on offer for the months ahead.



After several years of high waists – it was only a matter of time before these dropped once again, and here low slung can be seen trending again – taking us back to the 90s, with cargo pants and lower waist jeans – which might take a bit of getting used to for some.

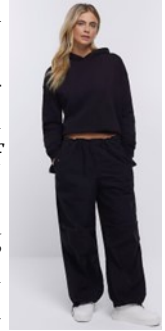

Cobalt blue is the colour of the season, taking centre stage across jackets, dresses, skirts and even footwear – which should be jumped on if you like a bit of statement colour rather than neutrals.

If you don't dare to wear brights, pinks come in softer candy floss subtle shades this season, complimented by romantic sheer floaty styles – which can be worn head to toe, or just compliment an outfit with accessories in this on-trend shade. But if it's pastels you prefer it's all about pastel blues, greens and greys – especially seen in soft tailoring.

Florals are always big for the summer and this year is no different, but there's a twist. Fashion sees theatrical 3D floral shapes and textures in our clothes.

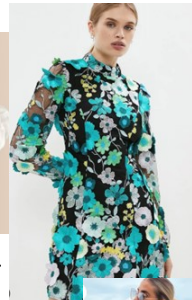

If after all this you prefer to play it safe, you'll be happy to know black is an unusual, but on-trend summer staple this year – but with a lighter touch which includes skin-baring fabrications such as crochet and lace allowing giving the look an unexpected softness.

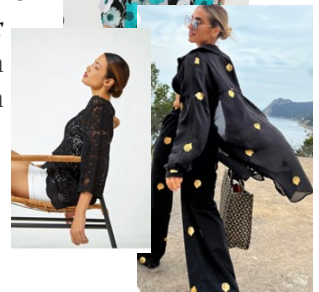

As always – take what you will, express yourself and have a bit of fun with fashion, feeling free to express your individual style

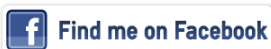

Lucy Roberts Personal Styling

Middlestown Primary Academy

Summer term is always a very busy one in school. This term we have sports week to look forward to where the whole school has the opportunity to participate in a range of different sports. This year the sports will include lacrosse, ultimate frisbee and wheelchair basket to name a few. It is always a very popular week in school which the children really enjoy. Following sports week will be our annual sports days which are incorporated with a picnic on the field.

We are very much looking forward to celebrating the King's Coronation. The children are going to be participating in Coronation Dance Workshops, making a whole school mosaic and will centre their learning around King Charles. On Friday 5th May we are holding a whole school picnic for the children and their families. This will include a parade of crowns made by the children and a performance from the school choir. We are hoping that the sun will be shining and we can mark this momentous occasion in a truly British style!

Our Year 6 children have a very important term ahead as they carry out their SATs assessments. Following these, they will be preparing for their transition to Secondary School. This will include transition days to their choice of High School as well as in school sessions. As always, the children will be fully prepared for their next steps in life. They will of course, have an end of year celebration and produce a final performance for parents where I am sure there will not be a dry eye in the house!

We have many school trips booked in for the final term going to places such as The Deep, Butterfly World and The Seaside! There are many fund raisers planned, our main one being the Summer Fayre which is always very popular. Once again, we hope for a lovely sunny evening.

A very busy term but one that everyone in school looks forward to!

DBL Plumbing and Ceramics

For all your domestic plumbing needs!

Full bathroom and kitchen installations
Outside plumbing service Central heating upgrades and replacements
All work fully guaranteed

Please call Darren for a no obligation quote on 07812 062888
Email Darren_lamb@live.co.uk Visit our website at dblceramics.co.uk

Recruiting Community Home Care Heroes



- Car drivers and own vehicle essential
- Competitive wage plus hourly bonus
- Pick up a shift bonus
- Paid travel time
- Paid mileage
- Work phone
- Use of company vehicle
- 2 week rolling rota/ alternate weekends
- Simply health cash back plan
- Annual pay rise and recognition
- Continuous training and development
- Progression within the company
- Guaranteed hours
- Full, part time, weekend & evening only positions
- Regular team and family events
- Recommend a friend scheme



If you believe you have the values and passion to be a Community Care Hero and support others in your local community, we want to speak to you.

Please call: 01924 274 448

Visit our website: www.completecareathome.co.uk

Email: hr@completecareathome.co.uk



Complete Care
West Yorkshire Ltd



St. Andrew's Church, Netherton

Greetings from St Andrew's Church Netherton

We have had a busy spring starting with pancake Tuesday followed by Mothering Sunday and several services during Easter week, including the children of Netherton Infant and Junior school coming into Church for an Easter celebration. We had a special afternoon service in March for families who had recent baptisms, followed by tea and cake. In May we celebrated the coronation of the King and we continue to pray that God will bless him and fill him with wisdom as he navigates his duties as head of state of our nation which is going through such enormous change.

We've had several christenings booked in through the summer and we are thankful to God for new life and families wanting God's blessings on their new-born children. As a church we are keen to extend a warm welcome to families and children and hope to see more of you over the coming months. We are planning to offer different types of services including a regular Sunday afternoon slot which we hope will be more suitable for families. All this will be advertised on our Facebook page.

Silver Fishes (a group for older people) goes on from strength to strength. They are planning a summer outing, an afternoon cream tea in June and will be inviting several interesting speakers over the summer months. In spring they had various activities like Easter crafts and the Fire Service come to talk to them about the work they do and offer advice about safety. This is a group open to vulnerable older people from Netherton, do feel free to drop in to see if you'd like to join.

Facebook page : St Andrew's Church

Vicar: Rev Hannah Hobday (01924 339072)

Events:

- Sunday morning services are at 9.30 a.m. (see our Facebook page for more up to date times in the summer)
- Silver Fishes (for older people) – every other Tuesday at 1 p.m.
- Netherton Scarecrow festival 1st and 2nd July – Refreshments served at Church

Jonathan Rushworth - Plumber

J.Rushworth
Plumbing & Heating

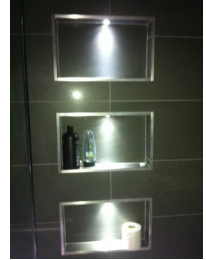

Plumbing and heating services

Bathrooms, wet rooms, tiling

Boiler installations, servicing and repairs

Power flushing

Wood burning stoves

Free quotations

Based in Horbury



Gas Safe register number 544316

M: 07814 428856 T: 01924 650109

E: jonathanrushworth@ymail.com

W: www.jrushworthplumbing.co.uk

A complete caring personal service provided by a family firm who have served Wakefield, Horbury, Outwood and the surrounding areas for over 80 years.

harpin's

FUNERAL SERVICE



When we die, we leave people in a state of shock and sorrow. At Harpin's we believe that some of the stress resulting from the loss of a loved one can be lessened by minimizing responsibilities. We offer reassuring and practical help to assist in making decisions thus helping to relieve some of your burden at a time of sadness.

Private Chapels of Rest at:

7, Back Mount Pleasant, Wakefield,
83, Cluntergate, Horbury
Victoria House, Victoria Street, Leeds Road, Outwood

Tel : (01924) 371091 / 272180 / 828238

www.harpinsfuneral.co.uk

Achieve peace of mind by being prepared.
Pre-paid Funeral Plans available.



Summer Magic

By Leslie Pinckney Hill

So many cares to vex the day,
So many fears to haunt the night,
My heart was all but weaned away
From every lure of old delight.
Then summer came, announced by June,
With beauty, miracle and mirth.
She hung aloft the rounding moon,
She poured her sunshine on the earth,
She drove the sap and broke the bud,
She set the crimson rose afire.
She stirred again my sullen blood,
And waked in me a new desire.
Before my cottage door she spread
The softest carpet nature weaves,
And deftly arched above my head
A canopy of shady leaves.
Her nights were dreams of jeweled skies,
Her days were bowers rife with song,
And many a scheme did she devise
To heal the hurt and soothe the wrong.
For on the hill or in the dell,
Or where the brook went leaping by
Or where the fields would surge and swell
With golden wheat or bearded rye,
I felt her heart against my own,
I breathed the sweetness of her breath,
Till all the cark of time had flown,
And I was lord of life and death.

Horticultural supplies at competitive prices

The Trading Hut

Home of the Horbury & District Allotments and Gardens Association
Southwell Lane, Horbury, Wakefield, WF4 5BG

Fertilisers,
Growing Medium
Compost,
Pest, Weed and
Disease Control,
Soil Conditioners

Onion sets
Shallots,
Broad Beans,
Seed Potatoes
Peas,
Dahlia tubers
Vegetable and
Flower seeds

Pots, canes, trays,
baskets, wire,
twine and netting

Membership starts
at only £2.50 pa

Supplies for
your garden,
patio, lawn,
greenhouse
and your
Allotment

The Hut is open:
10:00 – 11:45am every Sunday

Email: horburyallotments@outlook.com

www.horburyallotments.com

Est. 1929



RMT TV + Satellite Services

- Aerials
 - TV distribution systems
 - Freesat / Sky
 - TV / Home cinema set up
 - TV wall mounting
 - Cat 5 / Home networks
 - Repairs and problem solving
 - Building extension pre-wires
 - Installer of domestic and commercial CCTV
- 15 years experience
- Wakefield, Leeds and surrounding area
- No job too big or small

Richard Thompson
Based in Wakefield

Mobile: 07846 029745

Email: rmt72@icloud.com

NPTC **M P OTTS**
TREE SERVICES



FAMILY RUN FIRM - DOMESTIC & COMMERCIAL

- Tree Surgery • Hedging • Overgrown Leylandii Removal
 - Crown Raising/Thinning • Site Clearances
- Dangerous/Diseased Trees Removed • Logs Supplied

**PRIDE TAKEN IN ALL WORK
FOR A FREE ESTIMATE & ADVICE**

Call

**01924 264877 - Mobile 07976 453468
Old Rd, Middlestown**

LOGS

DRY HARDWOOD LOGS

**LOGS TO SUIT OPEN FIRES
OF ALL SIZES**

**FREE DELIVERY AND
STACKING.**

Netherton And District Women's Institute

Easter 2023 has been and gone. We were lucky with the weather having some lovely sunny days, but today it is blowing a gale and heavy showers are forecast with some a bit wintry on the tops! March winds and April showers all in one day but with the promise of warmer weather in May hopefully.

We had to cancel our March meeting because the whole of Netherton was completely without power from late morning until after dark (my power went off at 11.45am and didn't come back on until 11.45pm so it was early to bed for me! I did manage to find a torch and some candles though and my hob is gas so was able to cook something.

Tonight is our April meeting and we are having hot cross buns instead of biscuits which I am really looking forward to. Also the speaker, Ray Roberts, who is a magician and much more! We have had him before and he is extremely entertaining and very talented.

In May we have Wendy Bachelor on Traditional and Organic Hairdressing – and more. Not sure what organic hairdressing is – perhaps it's a cure for baldness, what do you think? All will be revealed I am sure.

June's speaker should be Pam Powers from TV's Bargain Hunt – that's on the 13th. We all love a bargain don't we? Perhaps we will learn how better to spot one, preferably one that's worth a fortune!

11th July's speaker is David Tompkins from the RSPB on Garden Birds many of which we are told are in decline. Should be interesting to perhaps learn which ones and what we can do to help them and try to reverse that decline.

And then it's August where every year we try and ramble after lunch but fail miserably. Perhaps we should reverse things and ramble first – and then we could eat more lunch!

We have Terry Webster on the 12th September whose subject is “Who Am I?” Perhaps we will learn how to research our family tree hoping to find

some royal ancestors. Who knows who we might uncover!

October is our AGM and Harvest Auction with fish and chip supper which is always very enjoyable.

The title of November's talk is "Mulengas Got Toilet Rolls". Now what do you make of that? Our speaker will be Michael Parkinson so you will have to come along to find out. That's on the 14th.

December seems a long way off now so we don't need to plan our Christmas Party just yet. But don't forget you need to be a member to enjoy the fun and games (and party food) so make haste and join our WI, you will be made very welcome. £2 on the door for 2 meetings before you have to decide, which includes light refreshments.

Second Tuesday in the month at 7.15pm in Trinity Methodist Church on Netherton Lane. You are welcome to give me a ring on 01924 275276 if you want to know more or just to have a chat.



Call Emma to book your space on 07789 901311

Netherton & Ossett Zumba

ZUMBA CLASS

£5 PER PERSON - UNDER 16'S £2.50

THURSDAY - 6:15 - 7:00PM
TRINITY METHODIST CHURCH, NETHERTON

South Parade Primary School



(in Partnership with The Castle Family Hub)



Tuesdays 8:50 – 10:15am

In the school hall

(Free entry via Classroom 5)

Activities for children and refreshments for adults

(Term Time only) (age 0 – 4 years)

Fairfield Road Ossett WF5 0DZ



New Albion House Limited
107 New Road
Middlestown
WF4 4PA

Tel No 01924 274251

140 seat function room available for hire for any occasion 2am License
Friday/Saturday if required.

Room hire costs Members £25 plus £25 returnable deposit
Non Members £50

1st Saturday in month Kids Disco starts 6pm

Live entertainment Saturday nights See Club noticeboard or Facebook page for details

Bingo Wednesday/Friday evening starts 8pm

Snooker, pool, darts and Sky Sports available.

Opening hours Sunday 12-11.30pm Mon/Weds 1-4pm 7-11pm Tuesday Closed all day
Thursday 5.30 -10pm. Friday/Saturday 12 noon till late



Funeral Partners

Wakefield
Funeral Services
(Thornes Park)

76 Horbury Road
Wakefield
WF2 8TU



Tel: 01924 372260
(24 Hour Service)

Tel: 01924 372260
(24 Hour Service)

- Personal Service with distinction
- Funeral Arrangements
- Repatriation services
- Pre-payment funeral plans
- Multi faith & Non religious ceremonies
- Woodland burials
- Advice and guidance
- Floral tributes
- Memorial Brochures & Price Lists

Visit our Website at:
www.wakefieldfunerals.co.uk

A Unique Tribute
to a Unique Life

Serving your community since 1934

A Fourth Generation Family Funeral Service

HOWARTH

Funeral Service

125 Denby Dale Road, Thornes

160 Alverthorpe Road, Wakefield

Incorporating

Blakey's Funeral Service

122 Painthorpe Lane, Craggstone

Proprietor

IAN HOWARTH Dip,FD.MBIE.BIFD.NAFD

PRIVATE CHAPELS OF REST - 24 HOUR SERVICE

PHONE DAY OR NIGHT

 **01924 376590**

Pre-Payment funeral plan available

: Catering Suite available



www.howarthfunerals.co.uk

Match The Scarecrow To The Theme

This year is the 11th Netherton Scarecrow Festival. Can you match entries from the previous 10 years to the theme?



Want to take part?
Check out the back page for
how to enter this year's
Scarecrow Festival!

2022 Films

2012 Cartoon Characters

2020 Heroes and Villains

2019 Children's Books

2018 Sci Fi

2017 Musicians

2016 Sports

2015 Disney

2014 Fairy Stories

2013 TV Shows



Sitlington Parish Council



Dear Residents

By the time you read this the parish council will have had an uncontested election. We have two new councillors who have been elected and the Parish Council will be seeking residents to also be Parish Councillors as there will be some vacant seats after the election process.

Look out for advertising of vacancies in the Parish.

Finance

The end of March will be the end of the finance and governance year for the parish council. The Parish Council is required by law to complete an annual return to ensure its finances and governance are transparent.

The Parish Council will undergo an internal audit and external audit, during this time there will be a chance for residents to view the accounts for the year under the Public Rights Notice. This will last for 30 days and will commence from July.

The dates will be advertised on the Parish Notice boards, the website and Facebook.

Hartley Bank community field/pavilion-Netherton

This space continues to be used well by residents and with the summer coming we are sure the extra bench donated by the scarecrow festival will be well used.

There has also been some planting of wildflowers by the Friends of Hartley Bank, supported by Wakefield Council open country group. This will help to give some additional colour to the field.

The Parish Council has been seeking quotes for refurbishment of the pavilion for use as a community space and investigating grant funding to support the costs.

Emroyd Common-Middlestown

Emroyd Common is a beautiful spot to walk through the woods, we have a new bench by the pond kindly donated by a resident.

The fairy trail was the idea of a resident, who worked very hard last year on the fairy trail. Some of this has been removed or vandalised which is a real shame.

We are working closely with the resident who did all the hard work last year to try and get this back up and running for the summer school holidays.

Gardening group

If anyone has green fingers and wants to get involved in our gardening group, please contact the Parish Office on the details below. This will commence in the spring with a meeting at the pavilion in Netherton to discuss work planned for over the summer.

Middlestown Cemetery

Access is required at all time to the cemetery Please DO NOT park in the semi-circle by the gate.

All dogs must be on a short lead while being walked within the cemetery. It is highly disrespectful to allow your dog to foul on any grave space as this is upsetting for the families. This is not an area for exercising dogs but a place of rest, the path should only be used to access the footpath at the bottom and into Emroyd woods.

Middlestown Cemetery has been undergoing a makeover, the older sections have had turf added to them and look so much better than before. We would also like to improve the top part of the cemetery by first of all replacing the trees that had to be taken down (the trees were affected by a fungus which had destroyed over half of the internal trunks making them at high risk of collapsing).

Have you any thoughts on which trees should replace them?

We would like the residents of Middlestown to have an input into the improvements so a meeting will be held in July to begin the discussions. Please watch for further information on the Parish council website, Facebook and the notice board at the cemetery.

Contact details: Mrs Julia Talbot, Parish Clerk.

Parish Office: 07771 113258, email: clerk@sitlingtonparishcouncil.gov.uk

Don't forget we have a website; the website has lots of information relating to the Parish Council.

www.sitlingtonparishcouncil.gov.uk

[@Sitparcouncil](https://www.facebook.com/Sitlington-Parish-Council)

NETHERTON VILLAGE HALL

The Parish Council is the sole trustee of Netherton Village Hall. It is run by a management committee and has admin support from the Parish Office.

We are currently updating the village hall website so hopefully by the time you read this it will be live <http://www.nethertonvillagehall.co.uk>

It will give you lots of information about the hall and classes we run. It is also an excellent space for children's parties.



The table top sales will also be returning to the village hall. Watch out for dates on Facebook and on the notice boards.

For Booking enquires please contact us on the Parish Office details on the previous page.

Whitby and back...

Not long ago I got an email from the NYMR (North York Moors Railway) with an offer I thought was really good! For just £40 you can get a season-long ticket and get on board the steam or diesel engine pulled trains between Pickering and Whitby as many times as you like.

As it happened, I was in Whitby last month to start my knee replacement recovery by walking 8 miles along the Cinder Path, the old and now disused railway line. Before leaving the next morning, I called in to the Railway ticket office to make sure I'd read the email right, then pre-booked my first trip to see how it would go.

Come the day I set off in what I thought was in good time, 7:15am, to get to Pickering in plenty of time to catch the 9:20am first departure of the day. The M1, however, had different ideas. What a nightmare. It took me 45 mins to travel about 5 miles to get from the Cedar Court junction to the 'new' M1 North exit just past the M62. Dear oh dear. Luckily the A64 was reasonably trouble-free but the minutes were ticking away... Turning off at

the Eden Camp exit onto the A168 traffic was interminably slow again caused by 2 of the slowest moving tractor and trailers... keep calm, keep calm, don't panic! I eventually arrived and parked up behind Pickering station and made it onto the platform and inside one of the old carriages with seconds to spare... phew. Now I could enjoy the ride!

It's a 24 miles journey calling at Levisham, Newton Dale Halt, Goathland (Heartbeat) and Grosmont, where the steam engine was replaced by a diesel before eventually pulling in to Whitby about 2 hours after setting off. The valley the route takes was lovely as ever. Although many of the trees and bushes were showing signs of early Spring a lot of the scenery reflected the Moorland surroundings and remained quite desolate with Winter hanging around for perhaps a few more weeks yet. In Whitby I walked up to and along the harbour East Pier extension to the lighthouse before buying some Fortune's kippers on the way back to the station cafe for a cup of tea and a bun (my weakness).



On the journey back I chatted to a number of happy passengers who were all enjoying their day. The Railway guards were also in good form. Back in Pickering I went straight to the ticket office to book my next ticket in early May! I'm glad to say that my drive home was less fraught and I was actually back in Netherton around 4:30pm. Not bad. If the weather is as good as it was on my first trip then I think next time I might get off at Grosmont, have a drink and bun in the station cafe (obviously) before walking to Goathland on the railway walk, about 3 and a half miles, and visit one of the cafes in the village there. Then it's a short stroll down to Goathland Station (Harry Potter's Hogsmeade) for the train back to Pickering. Can't wait!

Middlestown Patient Participation Group

PRACTICE TRAINING DAYS

The Practice is closed during the afternoon for training on the following days: 21 June 2023, 12 July 2023, 13 September 2023, 11 October 2023, 15 November 2023, 17 January 2024, 21 February 2014 and 13 March 2024. On those days if people call the surgery as normal on 01924 237100, they will be automatically transferred to GP Care Wakefield.

YOUR PPG NEEDS YOU

Middlestown PPG is seeking new members. We have a small, dedicated team but we would really like you to join us if you can. Make your voice heard by coming to join us. If you are interested ask at reception at Middlestown, Emley or Flockton surgeries.

Or you can email at Middlestown.Surgery@nhs.net

HAYFEVER, a common condition, also known as seasonal allergic rhinitis, affects around 1 in 5 people in the UK, often runs in families and is more likely to affect people who suffer from asthma and eczema. It is an allergic condition where the body's immune system overreacts to substances which are usually harmless, e.g. pollen from grasses, flowers, weeds or trees. Symptoms include sneezing, itchy, blocked or runny nose. red, itchy, puffy or watery eyes, itchy throat, headaches and sinus pain, fatigue.

Symptoms tend to be less severe if you reduce your exposure to pollen. The following may help when the pollen count is HIGH:

Stay indoors as much as possible and keep windows and doors shut.

Avoid cutting grass, large grassy places and camping.



- Shower and wash your hair after being outdoors, especially after going to the countryside.
- Wear wraparound sunglasses when you are out.
- Keep car windows closed and consider buying a pollen filter for the air vents in your car. These should be changed at every service.

The commonly used hay fever treatment options are Antihistamine tablets, Steroid nasal sprays and Eye drops. These can be purchased over the counter from your local Pharmacy.

If your hay fever symptoms are not controlled on the medication you are taking after 2-4 weeks, you should discuss this with your doctor. You may need to try a different treatment or add in another treatment.

If you are taking hay fever medication regularly and your hay fever is well controlled on your current treatment, you should continue this treatment until the end of the pollen season.

ARE YOUR DETAILS UP TO DATE?

Your up-to-date contact details, specifically your address and mobile telephone number are important. We often find people have moved or changed a mobile telephone number and have not updated this information. If incorrect information is held for you, it could mean a hospital letter informing you of a hospital appointment is sent to the wrong address for example. We will only ever use or pass on information about you if others involved in your care have a genuine need for it. We will not disclose your information to any third party without your permission unless there are exceptional circumstances (i.e. life or death situations), or where the law requires information to be passed on.

DID YOU KNOW?

BOWEL CANCER SCREENING over age 75. You can ask for a kit by phoning the helpline free on 0800 707 60 60. Kits are not automatically sent after you reach the age of 75.

BREAST SCREENING over the age of 70 can be booked by calling 0113 733 4974, Seacroft Hospital, Leeds. You can book an appointment every 3 years. Breast screening invitations are not sent automatically after age 70.

UNWANTED BOOKS: do you have any unwanted books in good condition? If so, take them along to the surgery where you can leave them to be sold. All money from the sales will go to charity. Enquire at Reception for more details.

Whatever you do and wherever you go this summer, take care in the sun; cover up and use plenty of sunscreen.

If you want to get in touch with the PPG then ask at Reception, phone 01924 237100 or email Middlestown.Surgery@nhs.net Leave your details and a member of the PPG will get in touch with you.

SIGNS OF STROKE:



You are invited to a
Coffee Morning & BBQ

Wine, Cakes, Tea, Coffee
Competitions, Tombola and Raffle

At

7 The Lawns Overton Wakefield WF4 4SF

From 11am – 4pm

On Saturday 2nd September

Donations of tombola items, raffle prizes and cakes
are gratefully received!

Every penny raised will be divided equally between

Macmillan
Cancer Support
2023

Parkinson's
Support Group
Wakefield

For further details ring Diane Brown on **07761121038**

Brand New Yoga Studio

Graphite House, High Street, Crigglestone, Wakefield, WF4 3EF

We have classes during the day and on evenings and weekends. We have classes suitable for all levels, including those who have never tried yoga before. We also offer beginners yoga courses, workshops and special events.

For details and booking, please visit our website:
www.yogologywakefield.co.uk

OUR TIMETABLE

Tuesday	Hatha Yoga, 5:45-6:45pm
Wednesday	Gentle Hatha, 10-11am Strong Vinyasa, 7-8pm
Thursday	Vinyasa Flow, 5:45-6:45 and 7-8pm
Friday	Yin Yoga, 6-7pm
Saturday	Vinyasa Flow, 9:15-10:15
Sunday	Sunday Morning Yoga, 9:30-10:30

Please follow us on social media to be kept up to date with workshops, new classes and special events.



@yogologywakefield



@YoGology



YoGology
yoga | meditation | sound healing

Netherton Accounting Payroll & Bookkeeping Services

I provide professional payroll and bookkeeping services to small and medium businesses in the UK.

I have had a bookkeeping professional qualification since 2003, and I started the business in 2004 as an offsite bookkeeping and payroll administration office.

Subject to a volume of transactions check, I normally charge £120 per month for bookkeeping and payroll.

Tax returns £250.

Contact Marco Vercelli

Tel 07974740779

e-mail marcovercelli@gmail.com

CELEBRATING LIVES WITH MEANINGFUL FUNERALS

Eric F. Box prides itself on arranging meaningful funerals that celebrate life, as much as they mourn the loss of a loved one.

We have served the communities of Yorkshire for over 150 years, and provide funeral services tailored to your exact needs.

General Manager, Edward Box lives in Overton and is the sixth generation of the Box family to work in the firm. Edward believes that his close connection with the local community enables him to make every funeral truly personal.

Your loved one and your memories are safe in our hands.

We offer:

- **Traditional, modern & eco-friendly funerals**
- **Celebration of life services**
- **Hearses & horse drawn carriages**
- **Traditional & eco coffins**
- **Pre-paid funerals**
- **Gravestone service**

For dignity and care talk to Eric F. Box.

For more information about our services visit the Eric F. Box website at:

www.efbox.co.uk

Chapel of Rest and viewing facilities at:

Bradford Road, Dewsbury, WF13 2EW

Tel: (01924) 465 402

7 Kingsway, Ossett, WF5 8DA

Tel: (01924) 271 612

E-mail: funerals@efbox.co.uk

The logo for Eric F. Box Funeral Directors Ltd. features the word "BOX" in a large, bold, white, sans-serif font with a black outline. Below it, the text "Eric F. Box (Funeral Directors) Ltd." is written in a smaller, white, sans-serif font, underlined.

BOX
Eric F. Box (Funeral Directors) Ltd.

Queen St. Garage

QUEEN ST. OSSETT

- ★ Servicing
- ★ Welding
- ★ Exhausts
- ★ M.O.T. Repairs
- ★ 100% Car and Customer Care
- ★ FREE Car Collection and Delivery Service to your Door

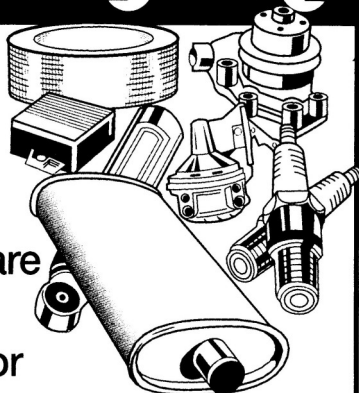

01924 263245 or 07790 788841

The Garage Door Team™

THE EASY WAY TO A NEW GARAGE DOOR

- Excellent choice
- Automatic garage doors
- Insulated doors
- Maintenance free
- Repairs
- Free no obligation survey
- Established 1991
- Family run business

01924 493822

www.thegaragedoorteam.com





QUALITY PERSONAL SERVICE YOU CAN TRUST
CALL ME TO DISCUSS YOUR REQUIREMENTS

SUE FIRTH

07774 226 073

01924 275176

I AM RELIABLE, TRUSTWORTHY, PROFESSIONAL
AND FULLY INSURED



FOREVER

Are you looking for a fun and lively speaker
for your group or organisation?

Aloe Vera

The elixir of youth!

One of Mother Nature's best kept
secrets.

Find out why people who drink **Aloe Vera** stay
younger, fitter, healthier and have less stress,
more energy and radiant skin.

Hands-on demonstration of the health and
healing benefits of aloe vera everyone gets to
touch, feel, smell and taste.

Contact Sue 01924 275 176
07774 226073



Local Professional Electrician & Security Systems

- Free quotations
- Domestic & commercial services include;
 - CCTV installation
 - Security alarms
 - Automated gates/garage doors
 - Electrical installation & repairs e.g. sockets,
lighting, fuse boards, rewiring



Tel: 01924 830516

07814035484

Email:

nick.siddall@ndselectricalservices.co.uk

www.ndselectricalservices.co.uk

Covering; Middlestown, Flockton, Overton,
Netherton, Midgley, Horbury & Wakefield

The Window Medic



Glass Replaced
Window & Door Locks
Upgraded Security
Anti-Snap Door Cylinders
Handles & Hinges
Mirrors
UPVC Door Panels
New Windows & Doors

ALL WORK GUARANTEED

Contact Andy
Office/Fax 01924 272 281
Mob: 07740 309 696

Email: thewindowmedic@gmail.com



Local company
Structural surveys
Structural Design Expert Witness

Surveys
we go beyond what 'Homebuyers Report'

Design
we can design in Steel, concrete and timber

Expert witness
unfortunately projects have their problems and you may need
Expert Advice and maybe even Court advice.

Chartered Engineers.
Our Principal Mr Julian Carter is a Fellow of the Institution of Civil
Engineers UK; FICE



email; hello@by-julian.com
tel; 0780 181 3141
web www.by-julian.com

English Garden Cocktail-

For 1 serving-

5 mint leaves
30ml gin
4 tsp elderflower cordial
2 tsp lemon juice
cloudy apple juice
ice and cucumber ribbon



Crush the mint leaves and mix with the gin, elderflower and lemon juice in a tall glass, fill with ice, top with apple juice garnish with a ribbon of cucumber.



REJUVENATE

MASSAGE THERAPY

www.rejuvenatemasagetherapy.co.uk

Treatments include:

Sports Massage

Dry Needling

Dry Cupping

Hot Stones Massage

Migraine/Tension Headache Therapy

Pregnancy Massage

Helping you relieve muscular aches and pains, reduce stress, promote recovery, and improve health and wellbeing.

07854709204

info@rejuvenatemasagetherapy.co.uk

Netherton, WF44NJ

One Summer Eve

July 28th – a memorable day. Summer is here, and what a joy it is to make the most of all that summer has to offer – long days, warm weather, a riot of garden colour - and time to relax in the evening with a glass of whatever takes your fancy. What more could anyone want?

One great grandson (yes, I am that old!) is playing football with his dad on the lawn. There's a lot of shouting and laughing going on midst the rough and tumble, and it's good to watch a four-year-old 'tackling' his dad. Then there's a pause for drinks before the game begins again. You store these memories for later on when the visitors have gone back home, when the house and garden are quiet again.

'When I was your age...' I was going to say, but I stop myself just in time - leave that to another day. Better for them to live in the present and enjoy the moment. Some day they might want to hear 'when I was their age'. Don't be a bore.

So, I leave them to their game. I stroll down to the bottom of my garden and slump on to the bench. It's so cool and pleasant just sitting here. The roses nearby are beautiful, deep red, pale pink and ivory, and the scent is quite exotic. Further over, the sweet peas are in full flower and climbing high up the trellis, with an abundance of yellows and reds and purples. They, too, have a wonderful scent. Hardy annuals and perennials fill the borders and it's heartening to see several bees on the night shift sipping the flowers before daylight fades.

In the distance, even the ever-constant hum of motorway tyres, usually so noisy, is muted, as I sit here. The sound reminds me of Keats' *mur'mrous haunt of flies on summer eves*'. Flies? Don't see many about these days, but that doesn't worry me.

A few yards away, my first earlies (Charlotte) and second earlies (Maris Peer) are just waiting to be discovered and eased from the ground. That's a job for tomorrow. There are few gardening pleasures to equal digging up potatoes. In the meanwhile, there's some earthing up needed with the main crop.

You can't sit long in a garden without noticing what needs doing. As I glance round, I can see some roses need dead-heading, and spraying for black spot; wayward strands of runner beans need tying up; there's weeding to be done between the rows of onions (Sturon and Ailsa Craig),

nipping out axil growths from the stems of tomatoes (Moneymaker) outside the greenhouse, and turning the compost heap over. Tomorrow I'll lower the blade on the mower ready for cutting the lawn. Oh, and, surprisingly, I suppose, begin pruning my cherry and plum trees.

Why prune now, not in winter, with the apples and pears?

Plum and cherry trees with their stones, as opposed to pips, tend to suffer more from Bacterial Canker and Silver Leaf (a fungal infection). It seems it's best to prune in summer when the tree is actively growing (firstly, it's better able to combat infection, and, secondly, diseases are less virulent at this time of year.) On the other hand, some experts say leave them well alone anyway! Don't touch them! Think I'll just give them a trim and see what happens.

So, there's plenty to be getting on with in the next few days. And watering, watering, watering – can't let plants dry out.

On the lawn the players are relaxing. My mind turns away from its ever-growing 'to-do' list.

When I was your age, little one... I think to myself, when I was his age, we had hardly any lawn. My father had an Anderson shelter built, which took up much of the back garden. About two million were built during the course of the war.

Anderson shelters? They were about the size of a normal greenhouse. The ground was hollowed out to a depth of about three feet. Corrugated iron sheets framed the sturdy doorway that led down three concrete steps. A right-angle turn brought you into the corrugated, roofed shelter where two plain benches faced each other on a concrete floor. On top of the corrugated iron roof was a foot-thick layer of concrete, with an iron mesh grid embedded in it, and on top of that was a thick layer of soil and turf.

And when the bombers were coming over us at night, intent on destroying Manchester and Liverpool, we sat in the near-dark of a candle gloom that cast eerie shadows on the walls, and we listened to the crack, crack of anti-aircraft guns from the ack-ack station a couple of miles away, hoping and praying that bombs wouldn't fall on us.

Terrifying times. Terrible times, all long ago. By luck or fate, the nearest bombs to us fell in the local park, doing little damage and hurting no one. (The late comedian Michael Craig's story pops into my mind. He said, you

may remember, that German bombers had strafed Batley for two hours – and done £8's worth of damage! Don't think people living in Batley saw the funny side of that story, but nice chap, Mike Craig – played golf with him once, and he was very entertaining, telling me about his interviews with famous comedians for Manchester radio.)

After the war, the shelter proved an excellent 'den' for my friends and myself.

And when I was your age, little one, my dad, who'd done four years' service in the First World War, and survived, would take his spade, and 'Dig for Victory'. Our garden became a vegetable plot, given over mainly to potatoes. We did what we could for the country, and potatoes helped us survive. There were few varieties of potato then – Arran Pilot, Epicure, then Majestic and King Edward VII, for example; now there are over one hundred different varieties.

But the JULY 1945 WARTIME GROWING GUIDE makes good reading and cautions growers not to use all the available space for potatoes; we must leave room for green crops, it says, especially winter greens. Nor was it the time to relax, but to get on and grow as many crops as we could – *'and so even if you feel like "just a little sleep", a little slumber, a little folding of the hands to sleep, don't indulge that feeling too often and do keep that hoe going'*. For the keen gardener, the Guide casts an interesting light on gardening in traumatic times. I recommend it.

How times change! Just to step back a little further while indulging in history, it was on July 28th, 1586 -the reason I chose today - Sir Thomas Harriott stepped off Sir Walter Raleigh's ship in Plymouth harbour from the New Found Land of Roanoke Island (in modern day North Carolina) with some tubers. *"Openavk' (no idea how it was pronounced!) are a kind of roots of round forme,' wrote Sir Thomas, 'some of the bignes of walnuts, some far greater, which are found in moist & marish (marshy) grounds growing many together one by another in ropes, or as thogh they were a string. Being boiled or sodden they are very good meate."* The descendants of these openavk were to become our staple daily dish - potatoes.

(Grandson and great grandson have said their goodbyes, and the house and garden are very quiet again in the setting sun. They have *'left the world to darkness, and to me'*.)

Well, July 28th – a memorable day indeed. Summer is here, and what a joy it is to make the most of all that summer has to offer, as I said before – and

now's a good time to relax in the evening with a glass of whiskey (or whisky!), or lemonade or whatever. What more could anyone want? We are so lucky.

So, for old times' sake, let's raise a glass to Sir Thomas Harriott – for bringing in the humble spud, the tatie, Burns' (neeps and) tatties, or, simply, potatoes, this day, 437 years ago! Cheers, Sir Thomas! At least you kept your head – unlike your boss, Sir Walter.

Jay Whittam

Netherton Walking Group.

We've had a good start to the year, amazingly again we've not lost a Monday due to bad weather yet!, long may it continue. Our numbers have consistently been around 20 from a pool of around 30 people.

Our walks have varied in location and terrain, regular walks cover a large geographical area, as far afield as Penistone, Stanley Ferry, the railways and canals of Dewbury & Digley reservoir, as well as locally. Our leaders provide us with information relating to the area, usually from a personal perspective.

We walk on a Monday, meeting at the village hall at either 9.00 or 9.30 depending on the destination of the walk. If you fancy a walk around 5 miles, with a good chat, we'd love to see you.

If you'd like to join us, take a chance on a Monday morning or contact the coordinator, Kath & Chris Gibbs on kathgibbs7@gmail.com to find out our start time.

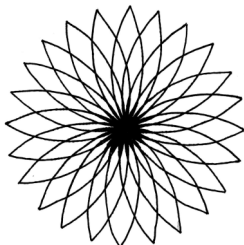

Reflexology by Darren
Angelic body mind & soul
at 55a Northgate, Wakefield, WF1 3BP
Reflexology/Reiki every Friday 10am to 5pm

Phone numbers; 07399 453 407
01924 373464 / 07812062888
Reiki-Darren@hotmail.com

<https://www.facebook.com/profile.php?id=100087482822407>



EARNSHAW'S

GODD WITH WOOD, GREAT IN YOUR GARDEN

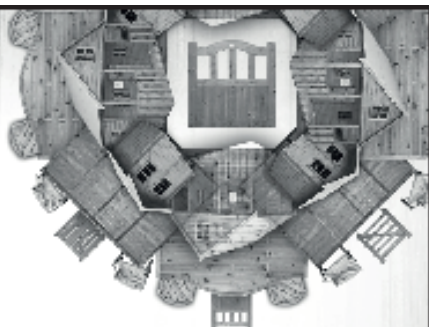

FROM GARDEN SHEDS TO GRAND DESIGNS

A unique range of natural garden and landscaping products – beautifully displayed at a centre near you.

- Gates
- Sheds
- Cabins
- Paving
- Timber
- Fencing
- Decking
- Water features
- Firewood
- Furniture
- Landscaping
- Outdoor heating
- Tools, fixings and accessories
- The Little Acorn coffee shop

Like us on:

[www.facebook.com/
EarnshawsFencingCentres](http://www.facebook.com/EarnshawsFencingCentres)



West Yorkshire Centre
Stocksmoor Road, Midgley, Wakefield
West Yorkshire, WF4 4JG

Sign up for a Loyalty Card
and start saving today

01924 830055

www.jobearnshaw.co.uk



Holmes and Sons

Est 1928

PAINTERS AND DECORATORS

Based in Netherton

All types of decoration work

Internal and External

Large or small

Insurance Work Welcome

Special rates for OAPs

Quality Workmanship by Professionals

Ring for a Free Estimate

Telephone David on 07802 464296

Netherton Film Club

The film club meets at Netherton Methodist Church on the 3rd Friday of the month. A selection of films is shown (usually certificate 12a or lower) with a wide range of subjects. We try to show films that have recently been shown in cinemas. This year, amongst others, we have shown Death on the Nile, The Lost King, & Mrs Harris Goes to Paris

Once a quarter on a different Friday Film Club extra shows more controversial films with a discussion taking place afterwards. in January we watched "Where The Crawdads Sing"

Why not come along and enjoy an evening out? There is no charge for the film but a donation to running costs is always appreciated.

Further details can be obtained from Christine Hewitt on 07931 353082.

Netherton Scarecrow Festival



There is still plenty of time to enter this year's Netherton Scarecrow Festival and we're looking to encourage lots of first time makers and previous makers to put their creative spin on this years theme.

This year the festival will be on the 1st and 2nd July 2023 and the theme will be Historical Figures/Famous People Dead or Alive.

You'll have noticed that we have expanded the category a little bit from the original; Historical Figures was proving a little too challenging for some so we've incorporated one of the other popular suggestions from last year into the mix. Famous people could include a sports star, pop star, politician, actor, scientist or even a Tik Tok Influencer!

We accept entrants right up until the last minute though to ensure that you get included on the trail map, the week before is the cut off for printing.

We'd love to hear from you if you'd be happy to host a scarecrow. We sometimes get groups or organisations looking for a location. Also, please get in touch if you'd like to make one but are out of the area. We'll find a place show off your masterpiece.



There are a number of different ways to contact us:

Via CoxleyLive.org

Via our Facebook Page [Facebook.com/NethertonScarecrowFestival](https://www.facebook.com/NethertonScarecrowFestival)

By email scarecrowfestival@talktalk.net

Call Adrian Woodhouse on 01924 281620

Printed by Lindley Print Design & Web, 70 George Street, Wakefield.

Tel: [01924 372567](tel:01924372567) Fax: 01924 367003 www.lindleys.biz